

5 on 0 Transition baseline drive Transition

Scenario 1

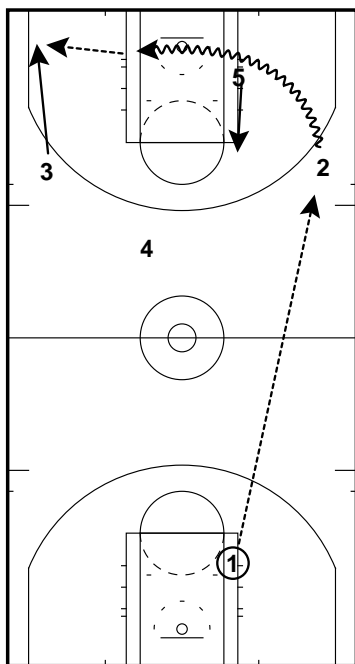

- 1 ball ahead to 2
- 2 baseline drive, kick to 3
- 3 scores

Scenario 2

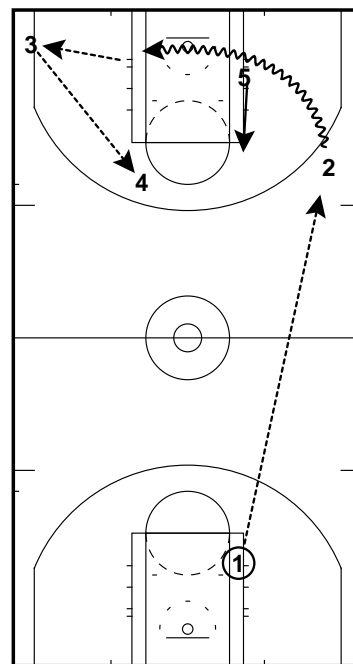

- 1 ball ahead to 2
- 2 baseline drive, kick to 3
- 3 passes to 4 "one more"
- 4 scores

Scenario 3

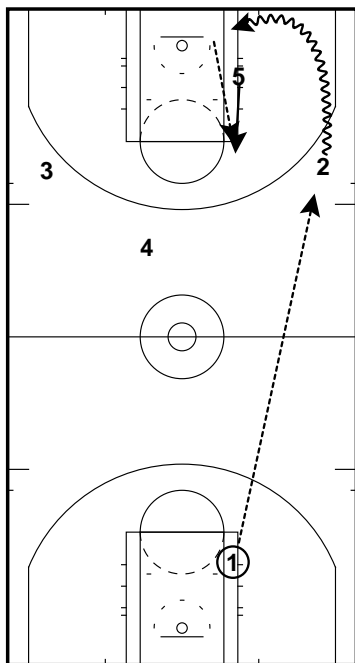

- 1 ball ahead to 2
- 2 baseline drive, pass to 5 on "I cut"
- 5 scores

5 on 0 Transition Build Up Through 5 Player Transition

Scenario 1

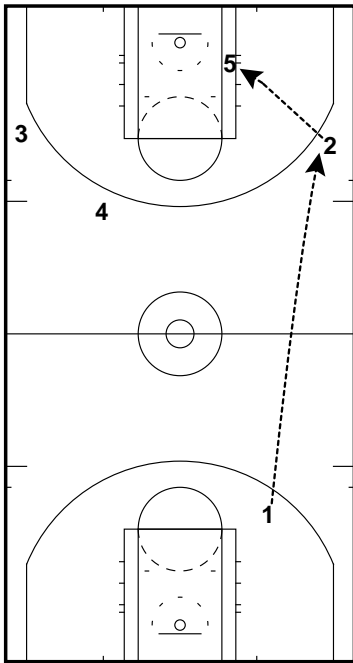

- 1 ball ahead to 2
- 2 passes to 5 (2 man game)
- 5 scores

Scenario 2

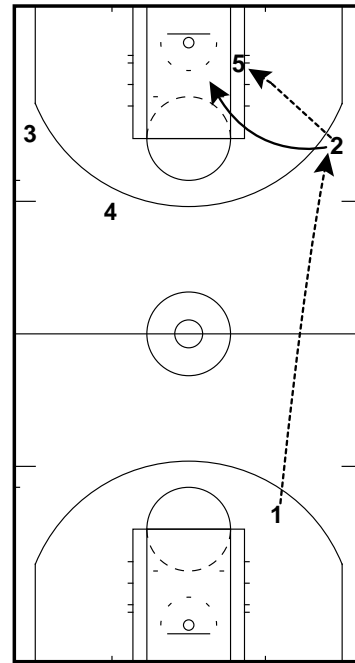

- 1 ball ahead to 2
- 2 passes to 5 (2 man game)
- 2 scores

Scenario 3

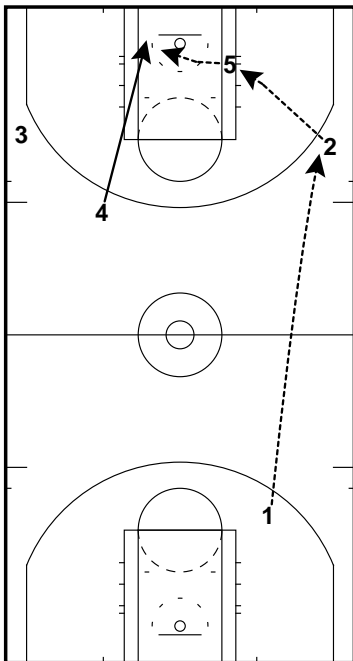

- 1 ball ahead to 2
- 2 passes to 5
- 5 passes to 4 (dive)
- 4 passes to 3 (slot shot)
- 3 scores

Scenario 4

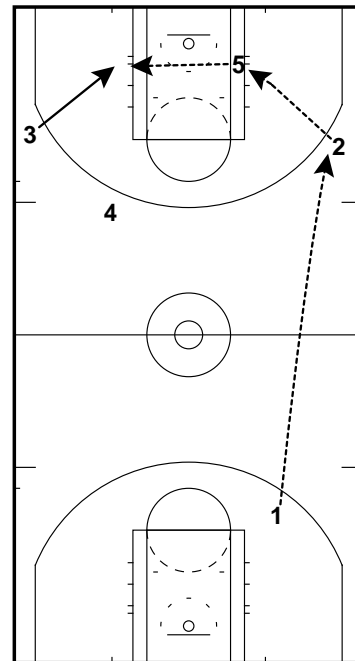

- 1 ball ahead to 2
- 2 passes to 5
- 5 passes to 3 (slot shot)
- 3 passes to 4
- 4 scores

5 on 0 Transition Build Up Through 4 Player Transition

Scenario 1

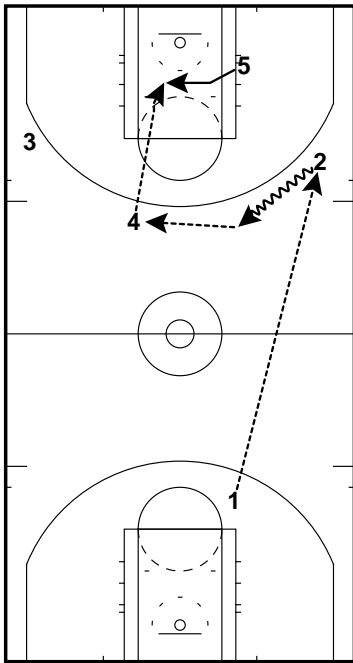

Scenario 2

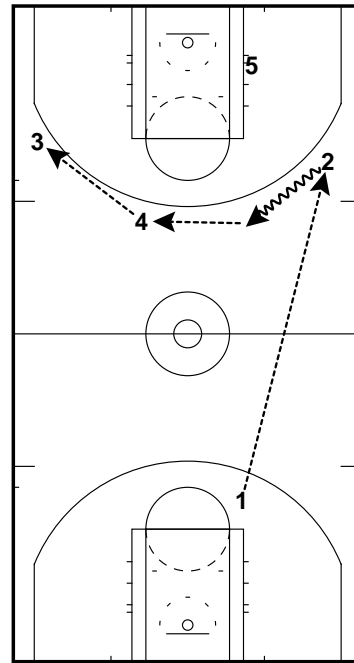

- 1 ball ahead to 2
- 2 passes to 4
- 4 passes to 5 (duck in)
- 5 scores

- 1 ball ahead to 2
- 2 passes to 4
- 4 passes to 3

Scenario 2

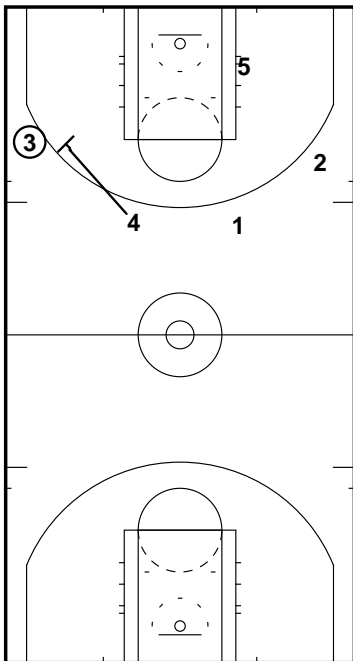

- 4 sets ball screen for 3

Scenario 2

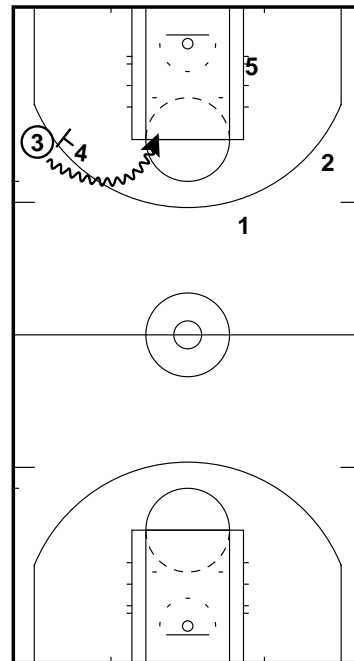

- 3 comes off ball screen
- 3 scores

5 on 0 Transition Build Up Through 4 Player Transition

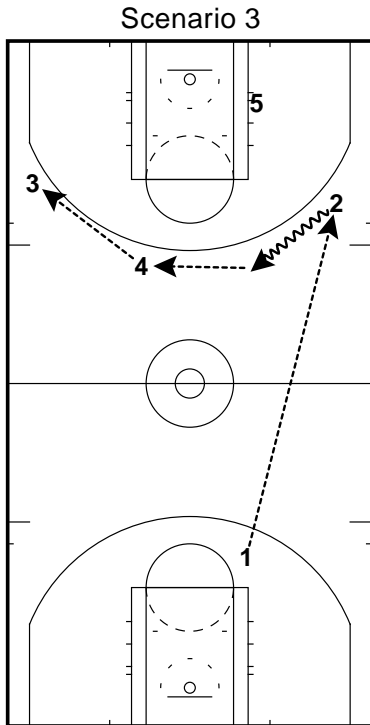

- 1 ball ahead to 2
- 2 passes to 4
- 4 passes to 3

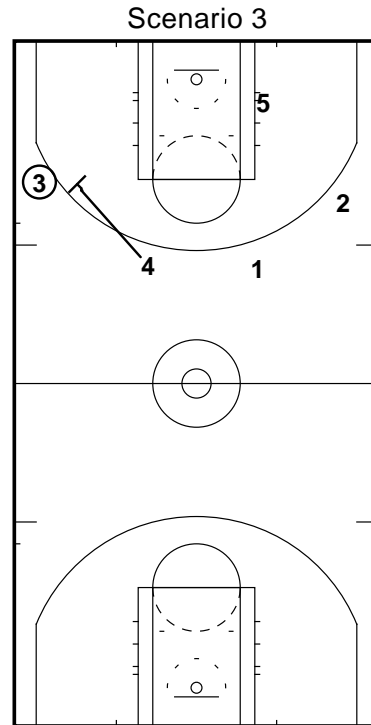

- 4 sets ball screen for 3

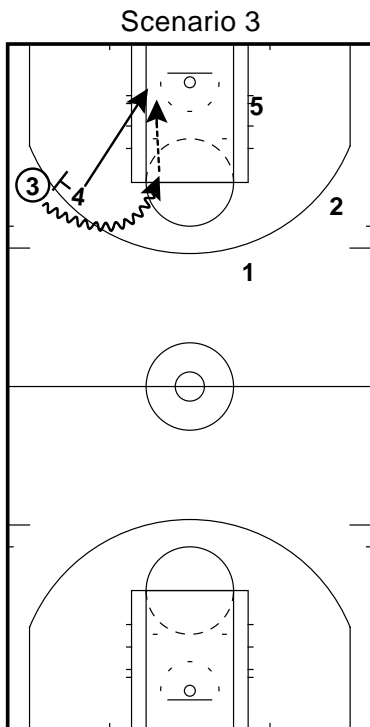

- 3 comes off ball screen
- 4 scores

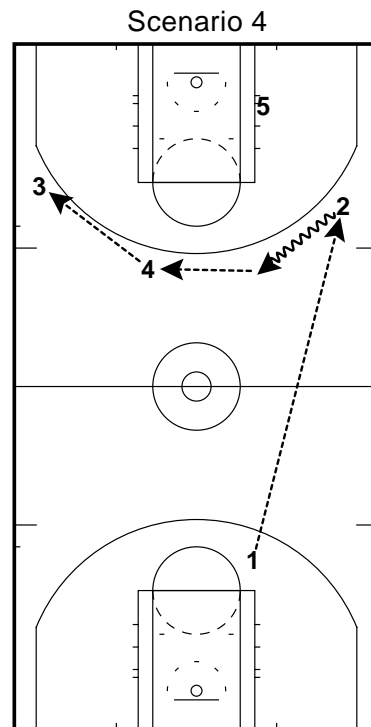

- 1 ball ahead to 2
- 2 passes to 4
- 4 passes to 3

5 on 0 Transition Build Up Through 4 Player Transition

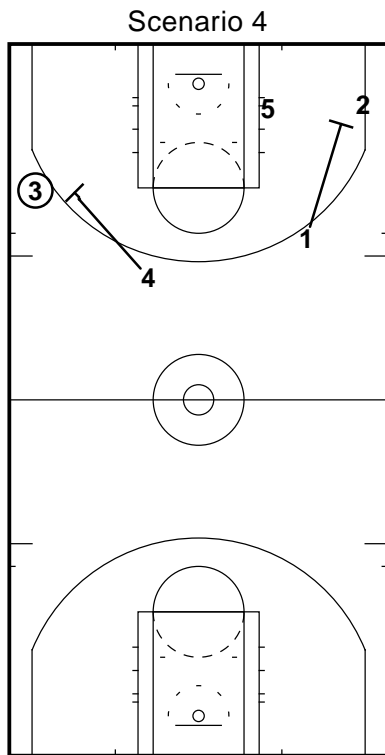

- 4 sets ball screen for 3
- 1 to 2 down screen

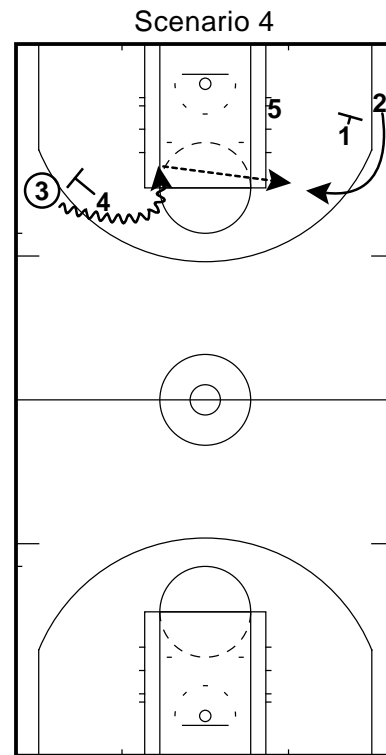

- 3 passes to 2
- 2 scores

5 on 0 step up & shoelace options

Transition

Scenario 1

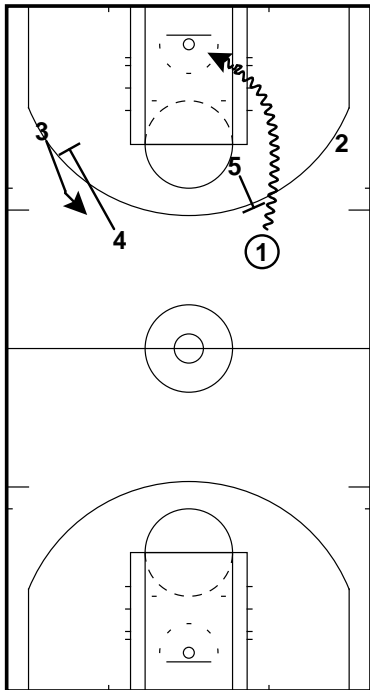

Scenario 2

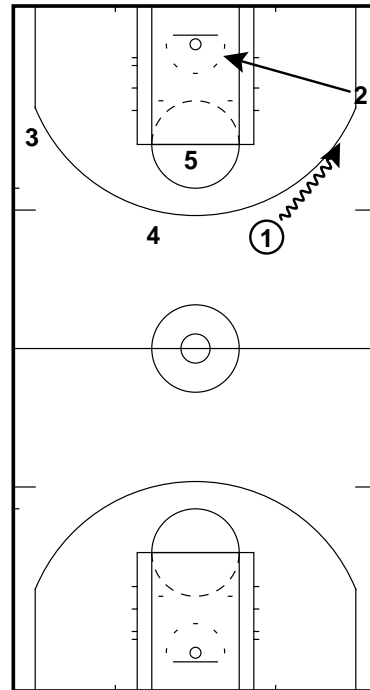

- 1 drives off of 5 step up ball screen
- pin down screen opposite side
- 1 scores

- 1 drives at 2
- 2 shoelace cuts
- 2 scores

Scenario 3

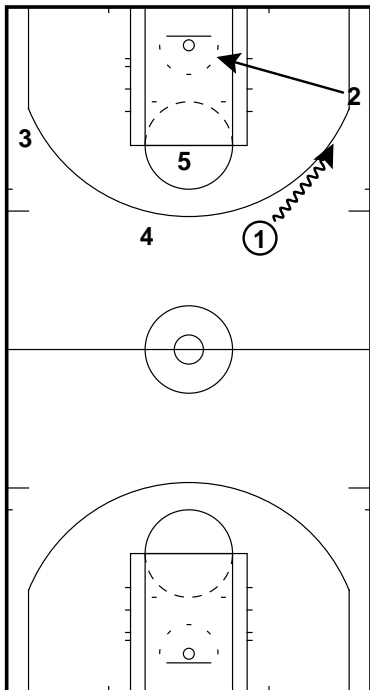

Scenario 3

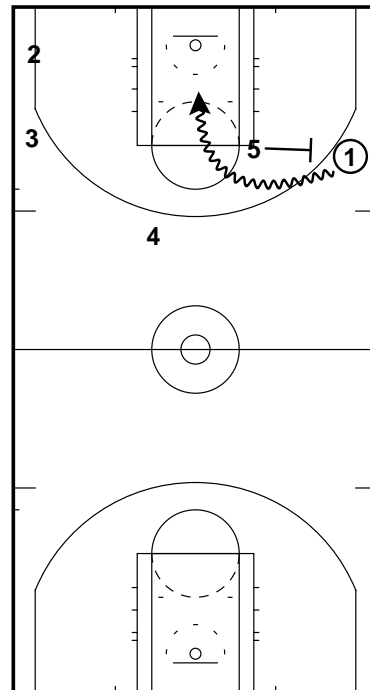

- 1 drives at 2
- 2 shoelace cuts

- 5 to 1 ball screen
- 1 scores

5 on 0 step up & shoelace options

Transition

Scenario 4

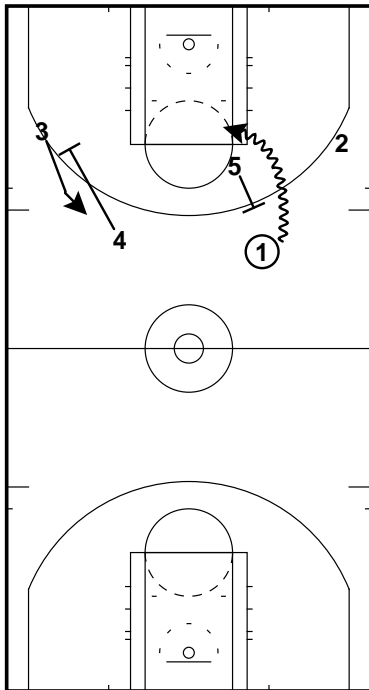

- 1 drives off of 5 step up ball screen
- 4 pin down screen for 3

Scenario 4

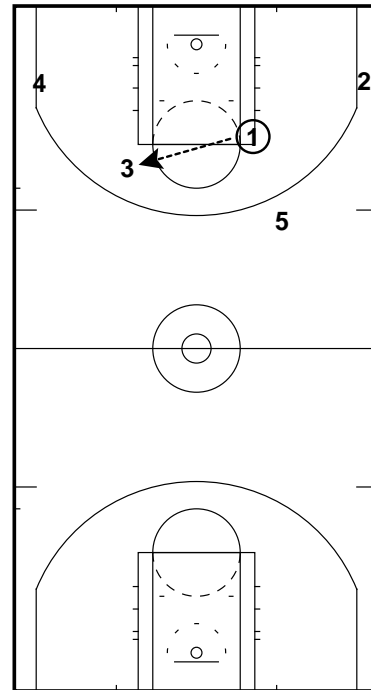

- 1 passes to 3
- 3 scores

Scenario 5

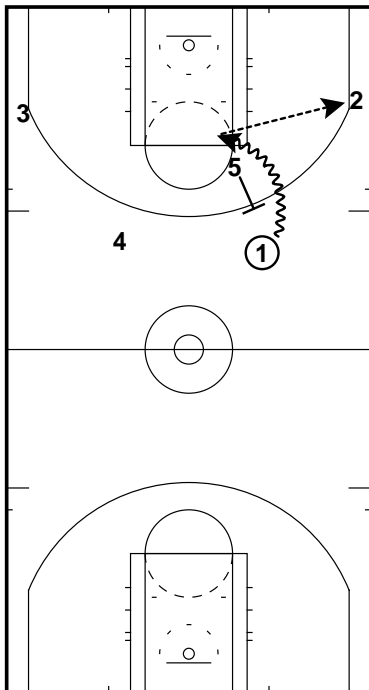

- 1 drives off of 5 step up ball screen
- 1 kicks to 2
- 2 scores

5 on 0 DHO Options Transition

Scenario 1

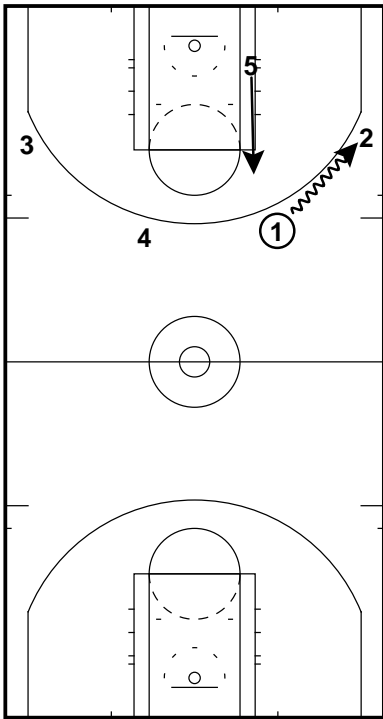

- 1 DHO to 2

Scenario 1

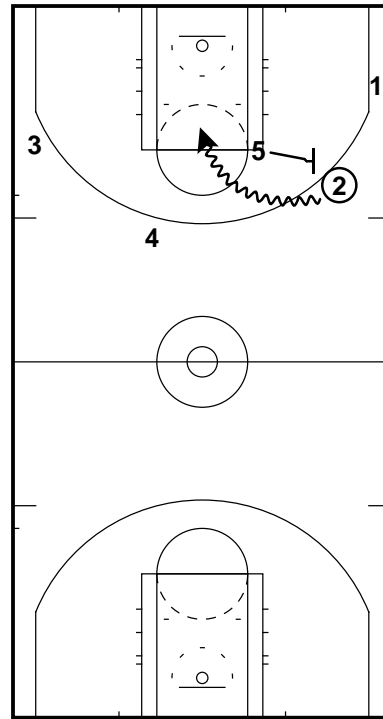

- 5 sets ball screen for 2
- 2 dribbles off ball screen

Scenario 1

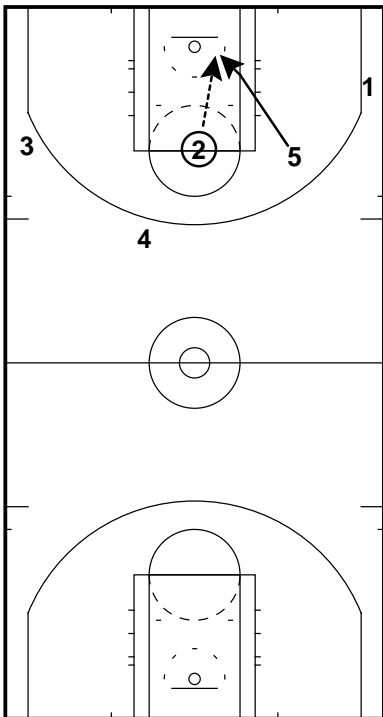

- 2 hits 5 (pick and roll)
- 5 scores

Scenario 2

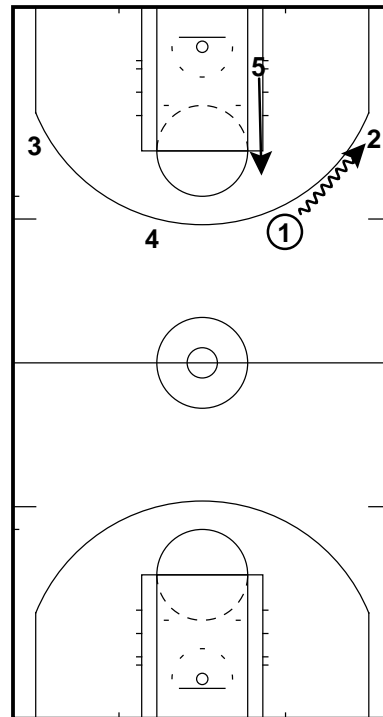

- 1 DHO to 2

5 on 0 DHO Options Transition

Scenario 2

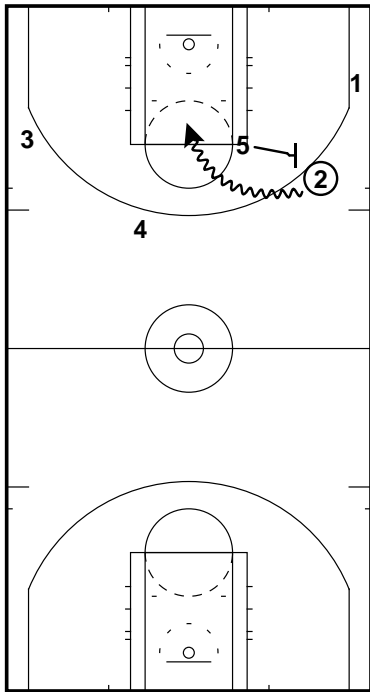

Scenario 3

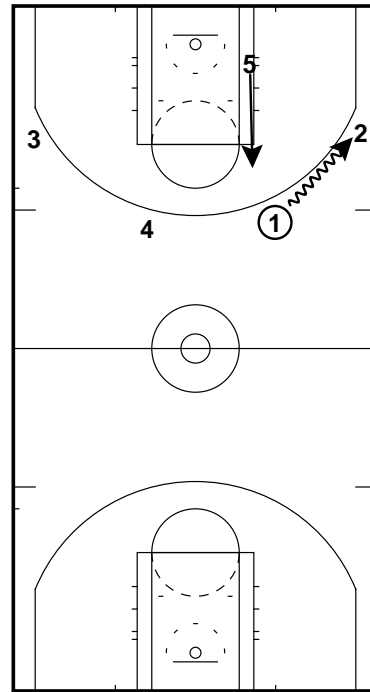

- 5 sets ball screen for 2
- 2 dribbles off ball screen
- 2 scores

- 1 DHO to 2

Scenario 3

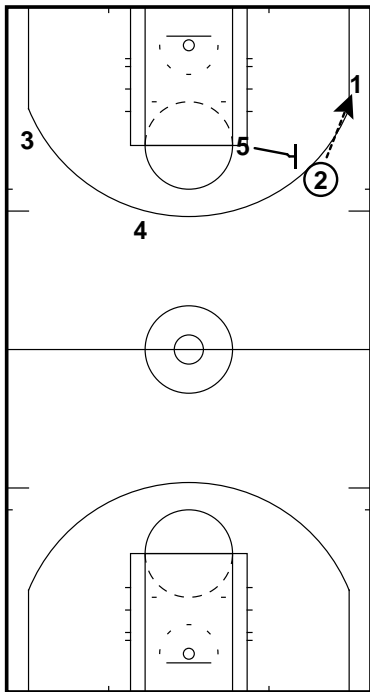

Scenario 3

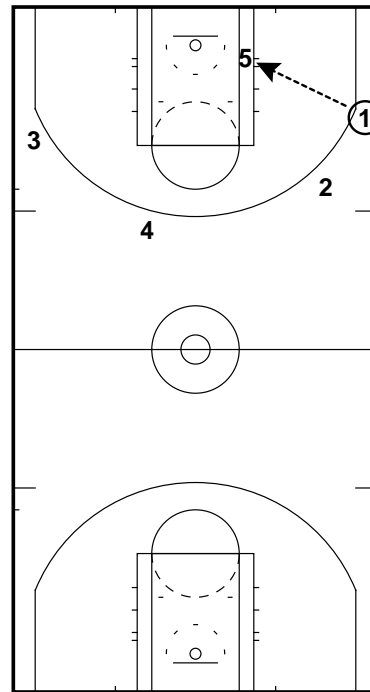

- 5 sets ball screen for 2
- 2 to 1 NAVY ACTION

- 1 passes to 5
- 5 scores

5 on 0 DHO Options Transition

Scenario 4

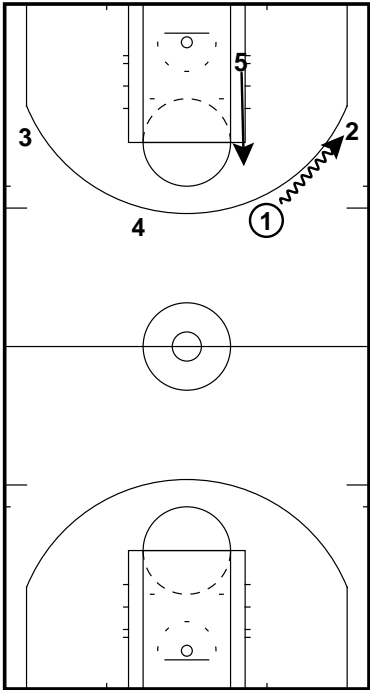

- 1 DHO to 2

Scenario 4

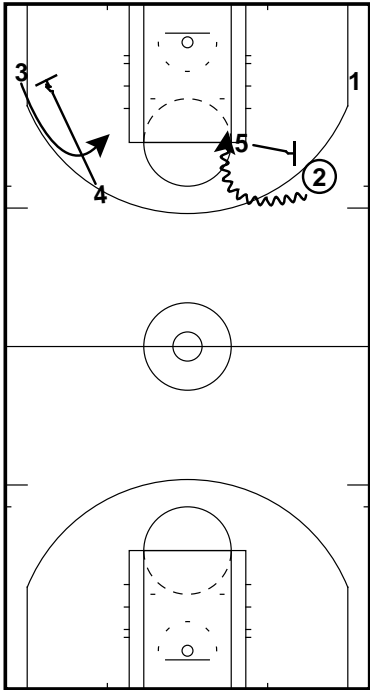

- 5 sets ball screen for 2
- 2 dribbles off ball screen
- 4 to 3 pin down

Scenario 4

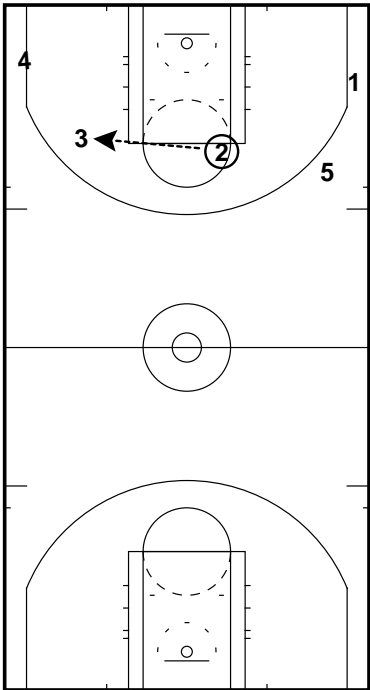

- 2 passes to 3
- 3 scores